



77700-900 Presence Sensor

Installation Instructions

DOR - O - MATIC®

7350 W. Wilson Ave.
Harwood Heights, IL 60706

Toll Free: 1-800-543-4635
In Illinois: 708-867-7400
Sales FAX: 708-867-0291
www.doromatic.com

PRODUCT SPECIFICATION

The 77700-900 Presence Sensor is an overhead-mounted diffused active infrared sensing device that provides detection for the triggering of automatic door safety functions. Applications include swinging, bi-folding and low-energy door operation.

The sensor is programmed to allow two different fields of detection - one for detection when the door is in the fully closed position and one for detection when the door is in the fully open position. While the door is in the fully open position, the sensor extends its coverage beyond the threshold area of the doorway, to allow coverage that will overlap that of the approach side motion sensor.

As with all of Dor-O-Matic's programmable sensing devices, full adjustability is achieved with the use of the 74610-900 universal hand-held remote control unit. This allows alteration of all of the available functions as well as checking existing settings. Should the need arise, the sensor may also be tuned by means of two sensor-mounted buttons contained on the PC Board within the unit. With these two buttons, the sensor's field of detection can be altered without the use of the hand-held remote.

TECHNICAL SPECIFICATIONS

Installation Height - Variable	9'-0" max. (recommended 6'-6" to 8'-0")
Mounting Angles	0°, +5°, +10° (factory default setting: +5°)
Power Supply	24 V AC / DC +/- 10%
Frequency	50-60 Hz
Output	Max. voltage at contacts: 60V DC / 125V AC Max. current at contacts: 1 A (Resistor) Max. power supply: 30 W (DC), 120V (AC)
Relay Hold Time	1 to 10 seconds
Operating Temperature	-22°F to +140°F
Immunity	Immune to electrical and radio frequency interference
Cable	6'-six conductor cable
Weight	1lb. 11 oz. (765g)
Dimensions	11.8"L (305 mm.) x 1.9"H (51 mm.) x 1.9"W (46 mm.)
Material	Aluminum & ABS plastic
Housing Color	Black anodized aluminum

INSTALLATION PROCEDURE

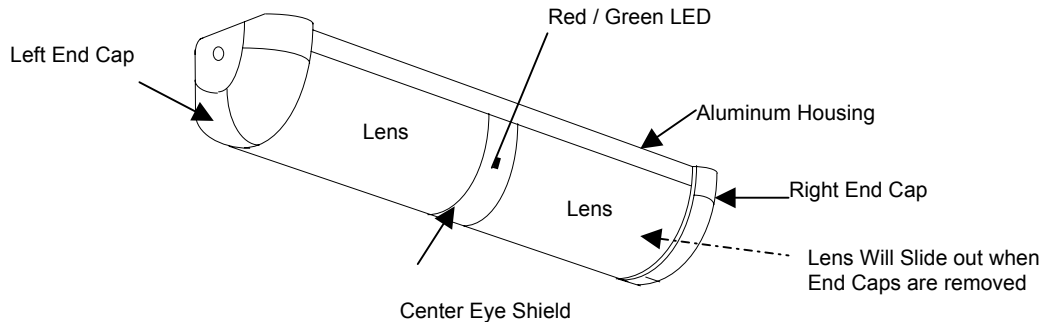

- I. Disassembly of Sensor for installation
Remove left & right end caps. Slide the 2 lenses out. Remove center eye-shield. Remove PCB Board.
- II. Sensor Installation
Install the sensor at the bottom of the header on the swing side of the door.

- III. Attaching HMS Spacer and Presence Sensor to Header
 The optional 87503-600 HMS Spacer shown below is used to allow the Presence Sensor to stand off from the door header by 3". This ensures that the detection field from the Presence Sensor will not be obstructed by the Door Mounted Safety Sensor during slight door movement caused by such adverse conditions as stack pressure within a building. The HMS spacer must also be used on doors that are hinge hung or have offset pivots.

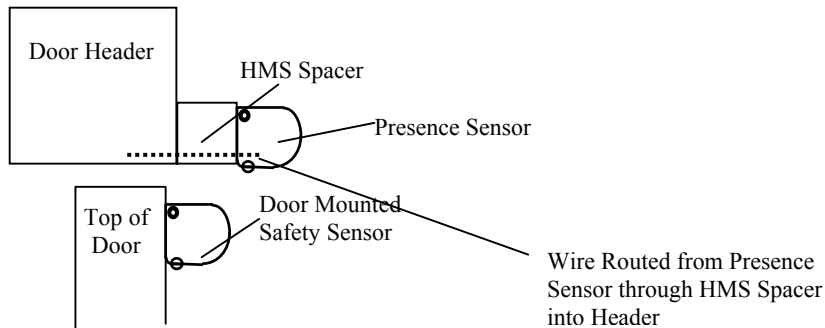

SETTING THE DETECTOR ANGLE

The sensor is factory preset at a 5° angle. To increase threshold coverage, the angle may be changed to 0°, or for coverage away from the door, change the angle to 10°.

The printed circuit board (PCB) within the sensor housing is held in place by two white plastic support clips. The clips are notched to allow the PCB to be set at 0°, +5° and +10° angles with the floor surface.

If a change in the angle of detection is desired, perform the following:

Remove both end caps, lenses and center eye shield. Remove one Pan Head mounting screw - does not matter which side - slide out the PCB and the white clips. Once this is accomplished, you can spread the white clips and re-adjust them to a different angle. Once angle is set, re-insert the PCB and the white clips back into the aluminum housing and re-install mounting screw. The PCB may be also be removed by pulling the bottom of the clip and rotating outward as shown below.

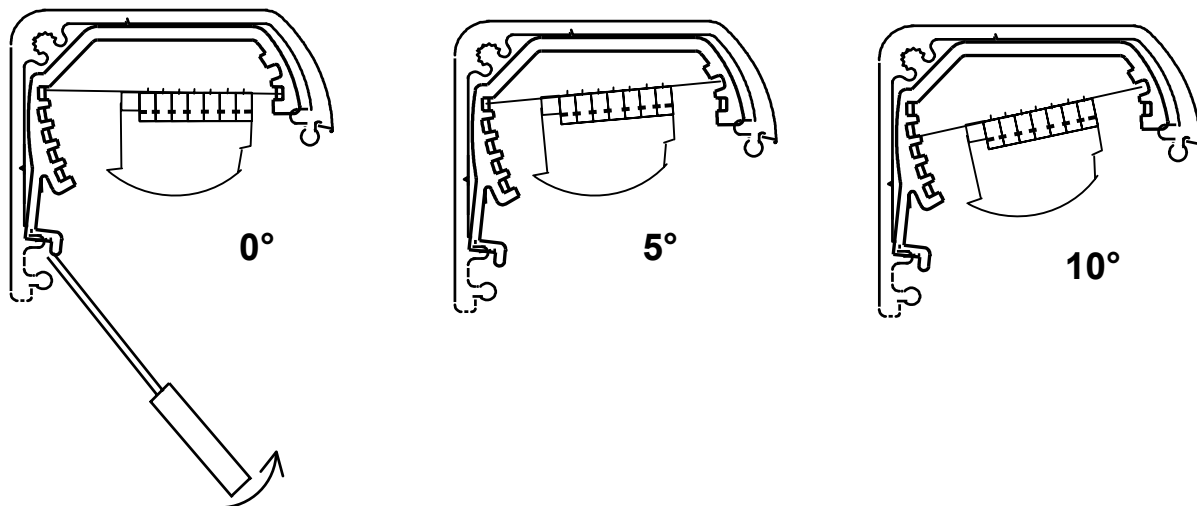

CAUTION
 REMOVE TERMINAL BLOCK OR REMOVE POWER FROM SENSOR BEFORE PROCEEDING WITH ANGLE ADJUSTMENT

WIRING DIAGRAM

Be absolutely certain that no power is applied to any wires until all wiring and connections are complete and the sensor is ready to be powered up and tuned. With the terminal block properly installed at the left side of the sensor, terminal #1 will be farthest from the mounting surface and the screws for the terminals will be facing down. The terminal block may be pulled out to allow ease of wiring. Once all wiring is complete, the lenses and center eye shield may be installed. Note: leave the end caps off until programming is complete in case the adjustment angle has to be altered.

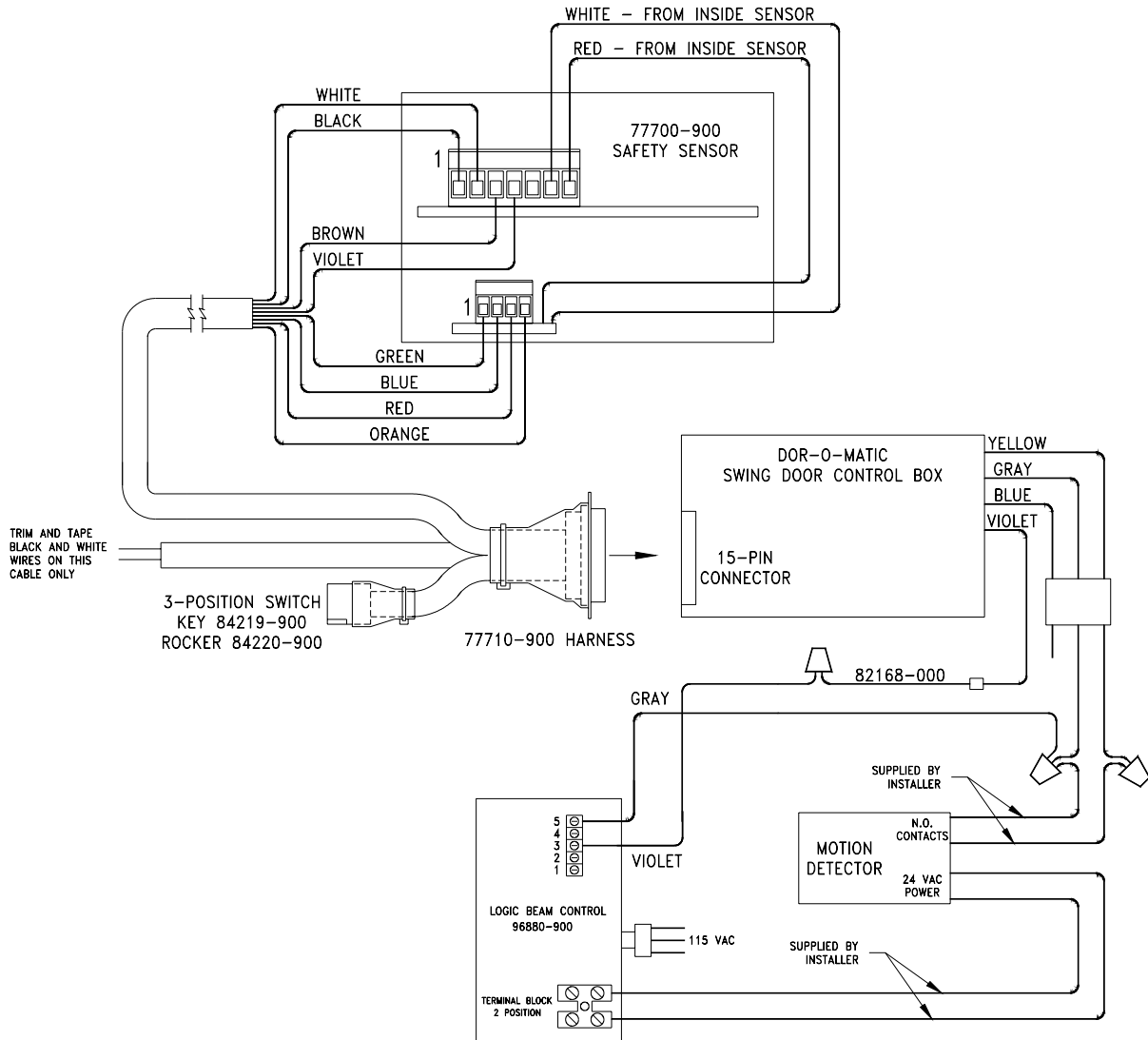

WIRING DIAGRAM FOR ASTRO-SWING CONTROL

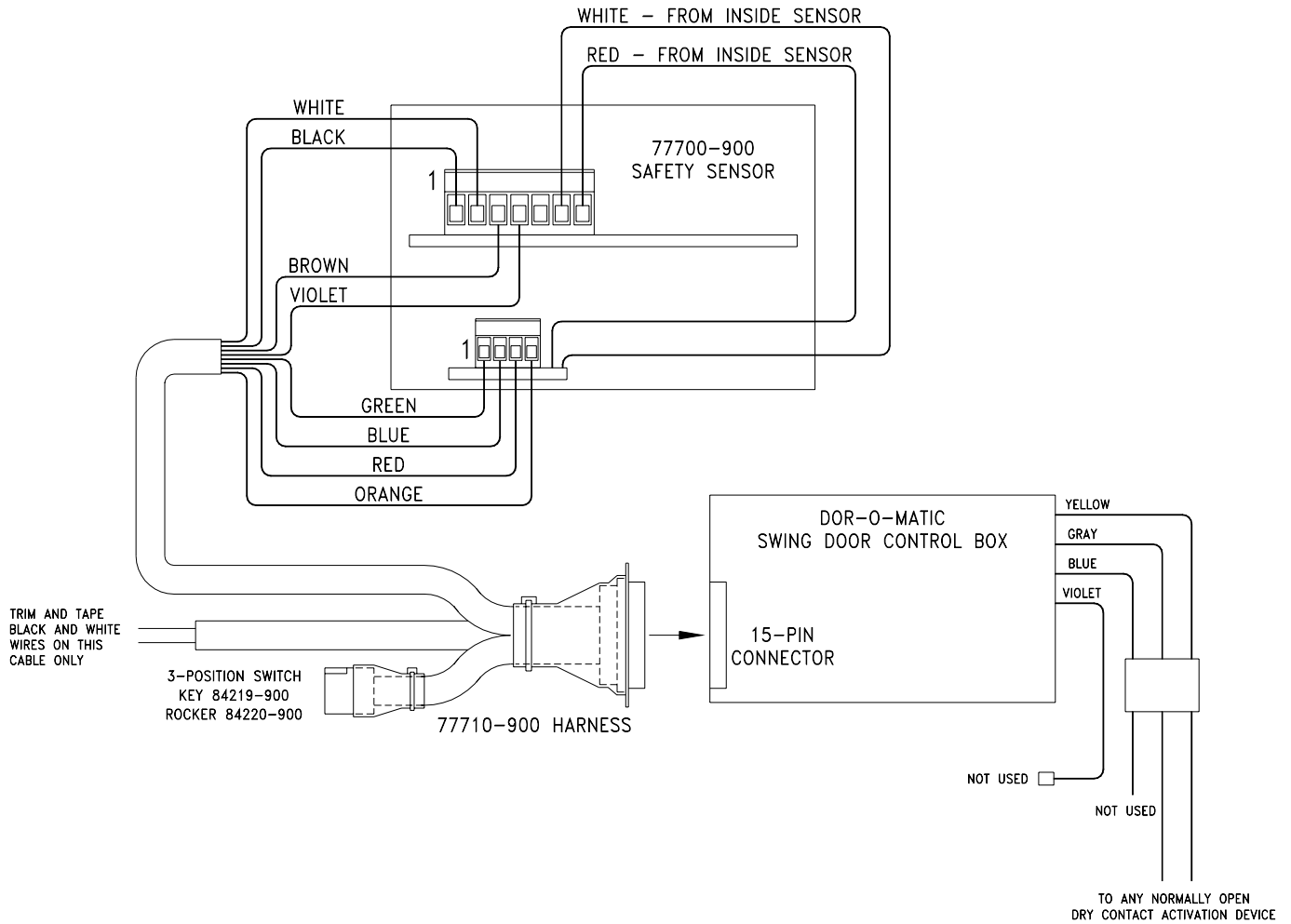

WIRING DIAGRAM FOR SENIOR-SWING & MID-SWING CONTROL

SWING DOOR OPERATOR CONTROL (LOW ENERGY) WITH OPTIONAL 77700-900 SAFETY SYSTEM

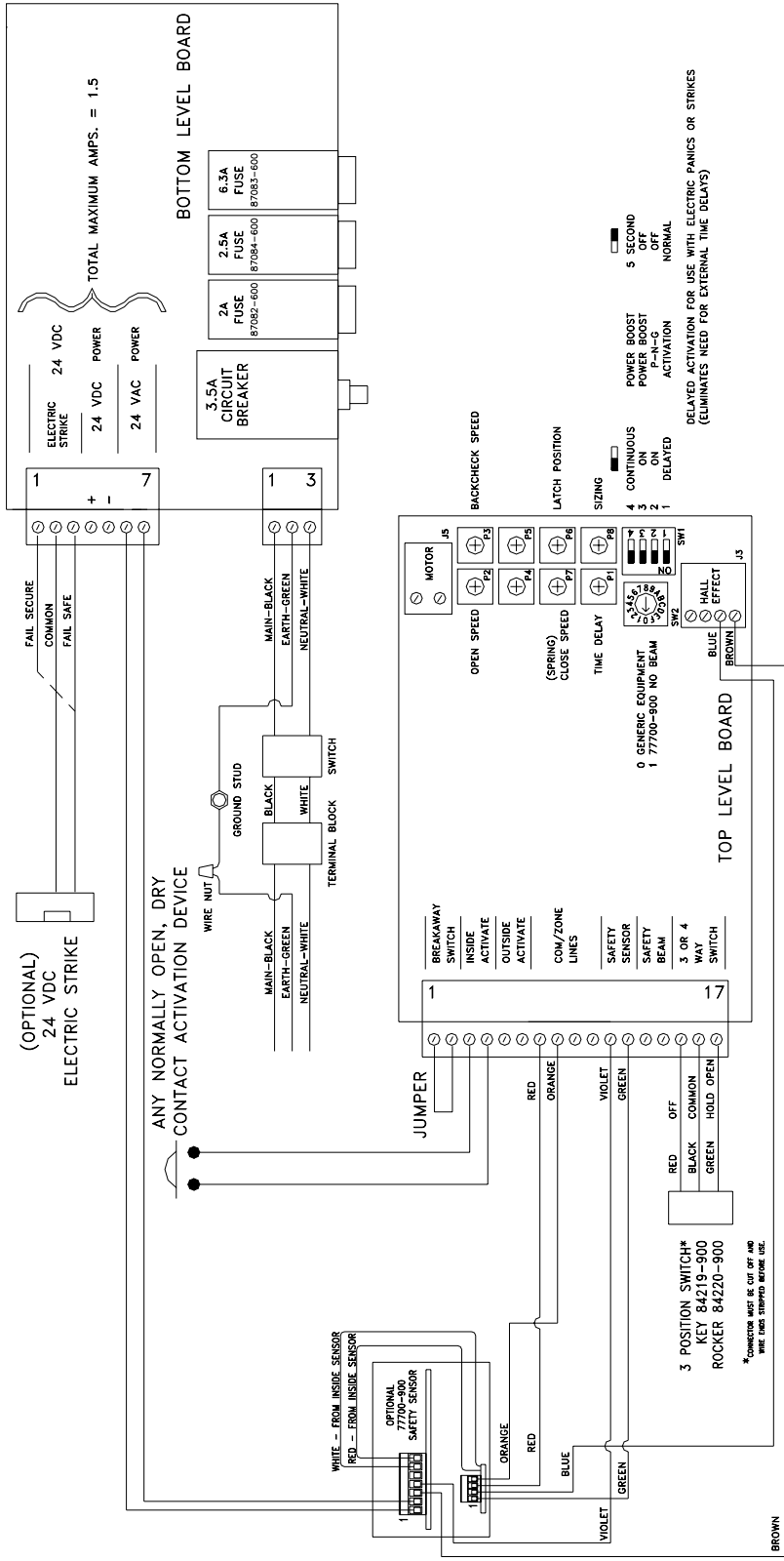



- P2: OPEN SPEED ADJUSTMENT. CW=SLOWER CCW=FASTER
- P3: BACKCHECK SPEED ADJUSTMENT. CW=SLOWER CCW=FASTER
DO NOT ADJUST THIS TO MAXIMUM SETTING. ADJUST AS NEEDED ONLY TO OVERCOME SPRING TENSION.
- P4: NOT USED IN THIS VERSION.
- P5: NOT USED IN THIS VERSION.
- P7: (SPRING) CLOSE SPEED ADJUSTMENT. CW=SLOWER CCW=FASTER
- P6: LATCH POSITION ADJUSTMENT. CCW=LESS LATCH CW=MORE LATCH
- P1: TIME DELAY ADJUSTMENT. CW=LESS HOLD OPEN TIME CCW=MORE HOLD OPEN TIME
DO NOT ADJUST THIS TO MAXIMUM SETTING. ADJUST AS NEEDED ONLY TO OVERCOME SPRING TENSION.
- P8: SIZING ADJUSTMENT. DO NOT ADJUST UNLESS SPRING IS SET TO HIGH TENSION POSITION. ADJUST AS NEEDED ONLY TO OVERCOME SPRING TENSION.
- SW2: FUNCTION SELECTOR SWITCH. 0=GENERIC EQUIPMENT 1=77700-900 NO BEAM

WIRING DIAGRAM FOR ASCENT & BENCHMARK PREMIUM CONTROL



SETTING UP USING THE UNIVERSAL REMOTE

The 77700-900 will automatically learn the door in the closed position after it is initially powered up – this is indicated by a flashing green LED. Then, the door must be activated so the sensor will learn the door in the open position.

1. **To Inquire about a Setting, complete the following:**



- Unlock the sensor by pressing the Unlock key .
- Press the desired function button followed by the Inquiry ? button. The green LED on the sensor will flash a certain number of times to indicate the current setting. For example, press the sensitivity button  followed by Inquiry ? button. The green LED will flash 8 times.

2. **To Change a Setting, complete the following:**

- Select the desired function button followed by a number. Refer to the quick reference guide for assistance.
- After the function button is pressed, the red LED will flash rapidly (+/- 10Hz). You will then have 30 seconds to make a numerical choice. If a number is not entered within the 30 seconds, the sensor will go back into Lock mode and keep the default setting. For example, press the Auto Learn Time Button  followed by number 2. The Learn Time will then be set for 2 minutes.
- Once you are finished programming the sensor, you must then store the changes into permanent memory so they are retained if there is a power loss. Press the Lock key twice to retain all changes. 

3. **To Save Changes, complete the following:**

- Press the lock button  twice. The red LED will flash at a rate of +/-1Hz after pressing the lock button once. Then the red LED will turn off after pressing the lock button again.

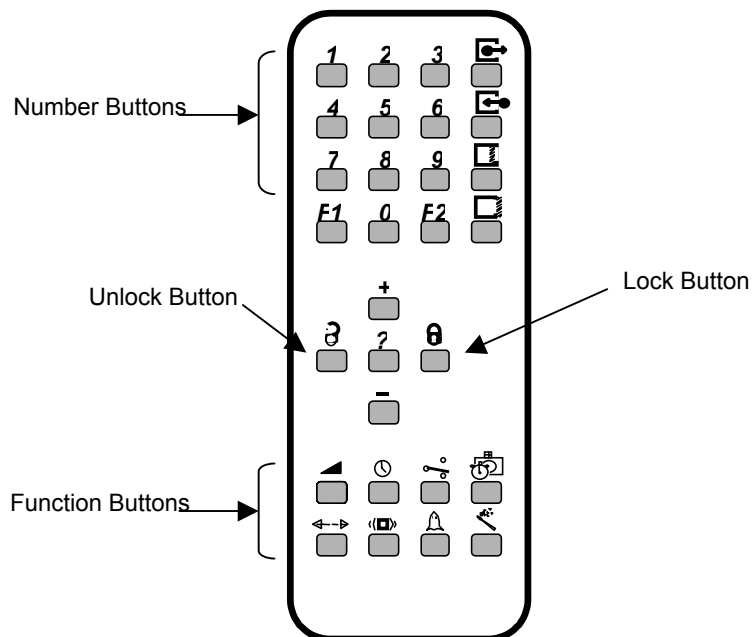

NOTE: The Bodyguard will Auto Learn (green LED flashing) if the sensitivity , pattern selection,  or pattern depth  was changed during the set-up.

Universal Remote Control 74610-900



CHANGING THE ACCESS CODE

To change the access code from the factory default setting of 0000, you must complete the following:

1. Think of a 4-digit code that will be easy for you to remember.
2. Press the  button after making the necessary changes to the sensor. After pressing the  button, enter your 4-digit code.
3. Each time you need to change the sensor settings, you must then press the  followed by the 4-digit code you have set.
4. If the sensor is locked and you do not know the access code, power the sensor off, then power it back on. Press the Unlock key within 60 seconds of powering. When programming is complete, lock the sensor with a new code, or with the default code of 0000.

QUICK REFERENCE GUIDE

Dor-O-Matic recommends reading through this guide prior to your installation. We have designed this quick reference to help you while you are in the field. **THIS IS NOT TO REPLACE YOUR INSTRUCTION MANUAL!** The 77700-900 is programmed with factory default settings. They are defined in the following steps. **REMEMBER!** If at any time the factory defaults are appropriate for your application, you do not have to change them. Only change the parameters that are needed for your application.





INSTALLATION

- Position the sensor at the bottom of the header on swing side of the door.
- Utilize the mounting block (87503-600 HMS Spacer) when your doors are loose and partially open due to stack pressure or wind. Also use 87503-600 HMS Spacer if you are installing 87500-900 door mounted sensors with offset pivot or hinges.









SET-UP

- The sensor will automatically learn the door closed position after it is initially powered up. You must then activate the door so the sensor will learn the door in the open position.

PROGRAM

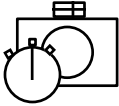
- Point the remote control towards the sensor (the receiver is located inside).
- Start your programming phase by pressing the Unlock button . The sensor has a 4-digit access code to prevent unauthorized programming. The sensor is factory preset to have the code of 0000. If you are using the 0000 code, you will not have to enter the 4-digit code into the remote. You can begin programming immediately after pressing the  button.
- You must then press a function button, followed by a numerical value.
- After making all of the necessary changes, slowly press the Lock button  twice or the Lock button  with your access code. This will close your programming session.
- Make all necessary changes in the door-closed position first. Then make changes to your pattern width, depth, and sensitivity in the door open position.

PROGRAMMING - "CHEAT SHEET"

Function Buttons	Actions	Factory Settings
 SENSITIVITY	Press this key followed by the number button (0-9) of the sensitivity desired. 0 - Minimum 9 - Maximum	Door Closed = 8 Door Open = 8
 RELAY HOLD TIME	Press this key followed by the number button (0-9) to enter the required hold time. 0 = 1 second 1 = 2 seconds 2 = 3 seconds 3 = 4 seconds 4 = 5 seconds 5 = 6 seconds 6 = 7 seconds 7 = 8 seconds 8 = 9 seconds 9 = 10 seconds	1 Second
 PATTERN SELECTION	Press this key followed by a number button (1-9) to select the required pattern. This setting can be selected for both states of the door, DOOR OPEN or DOOR CLOSED. 1 = Wide pattern 2 = Middle pattern 3 = Asymmetric left narrow 4 = Asymmetric right narrow 5 = Narrow left 6 = Middle pattern 7 = Asymmetric left wide 8 = Asymmetric right wide 9 = Center narrow	Door Closed = 1 Door Open = 2
 RELAY MODE	Press this key followed by a number button (1-4) to select the required relay output desired. 1- Passive output , relay contact open during detection, closed during non-detection 2- Active output , relay contact closed during detection, open during non-detection 3- Continuous detection , relay contact always closed 4- Continuous non-detection , relay contact always open	Passive
 AUTO LEARN TIME	Press this key followed by a number button (1-9) to select the required auto learn time. 0 = 30 seconds 1 = 1 minute 2 = 2 minutes 3 = 3 minutes 4 = 5 minutes 5 = 7 minutes 6 = 10 minutes 7 = 15 minutes 8 = 20 minutes 9 = 25 minutes	30 Seconds (0)
 FREQUENCY	Press this key followed by a number button (1-2) to select the required frequency. 1 = normal frequency 2 = random frequency 1 3 = random frequency 2	Random Frequency 1 = 2
 INQUIRY	Press this button after pressing a function button. Then count the number of times the LED flashes. This corresponds to the status of the parameter in question.	No Setting
 MAGIC WAND	Press this button followed by a number button to launch the desired set-up. 1 = Launch closed door setup (door must be closed) 2 = Launch open door setup (door must be open) 3 = Automatic set-up 4 = Reset to factory default settings	No Setting
 PATTERN DEPTH	Press this button followed by a number button (1-3) to choose your desired pattern depth. 1 = deep pattern 2 = medium pattern 3 = limited pattern	Door Closed = 1 Door Open = 1

NON-REMOTE SETUP

If you are in the field and do not have a universal remote control, you may set-up the 77700-900 using the manual push buttons (see diagram below) located under the right end cap. Keep in mind, you can only set up the sensitivity, relay mode, pattern width, and pattern depth with the manual push buttons. To set up the sensor without a remote, complete the following:

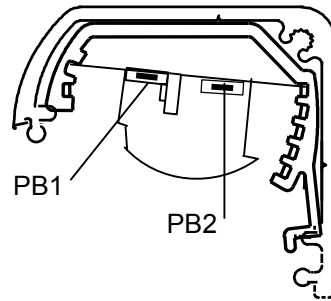

1. **To start the set-up process, press PB1 (for less than 2 seconds)**
 - The set-up function will be launched according to the current door position. The green LED will flash at +/-2 Hz for 10 seconds. This LED will stop flashing when you achieve a successful set-up.
 - If there is an interruption to the field of detection during this procedure, the green LED will flash at a slower rate. You must then press PB1 to launch the set-up again.
2. **To change the detector's parameters, press PB1 (for more than 2 seconds), and then release the button.**
3. **Press either PB1 or PB2. The LED will immediately flash red, followed by a sequence of green flashes.**
4. **The red flashes indicate the parameter and the green flashes indicate what that particular parameter is set to.**



NOTE: Pressing PB1 will toggle between the parameters and pressing PB2 will toggle between the range of adjustments for that particular setting. Once you achieve the highest adjustment, you will go back to the lowest setting by pressing PB2. For example, a value of zero (0) will not flash green; a value of one (1) will flash green one time.

5. **To exit manual set-up, simply wait 20 seconds or press PB1 for more than 2 seconds. Place the right end cap back on the sensor.**

RED LED STATUS	PARAMETER	SYMBOL	DESCRIPTION	GREEN LED STATUS
1 Red Flash	1		Sensitivity (Door open)	0 – 9 Green Flashes (default = 8)
2 Red Flashes	2		Sensitivity (Door closed)	0 – 9 Green Flashes (default = 8)
3 Red Flashes	3		Relay Mode	1 – 4 Green Flashes (default = 1)
4 Red Flashes	4		Auto Learn Time	0 – 9 Green Flashes (default = 0)
5 Red Flashes	5		Pattern Width (Door Open)	0 – 9 Green Flashes (default = 2)
6 Red Flashes	6		Pattern Width (Door Closed)	0 – 9 Green Flashes (default = 1)
7 Red Flashes	7		Pattern Depth (Door Open)	1 – 3 Green Flashes (default = 1)
8 Red Flashes	8		Pattern Depth (Door Closed)	1 – 3 Green Flashes (default = 1)

ONCE THE SET-UP PHASE IS COMPLETE (MANUAL OR REMOTE), WALK TEST THE FIELD OF DETECTION TO ENSURE ADEQUATE COVERAGE AND COMPLIANCE WITH ANSI STANDARDS.

PATTERN CHARTS

The following charts correspond with the width and depth patterns of the sensor. Keep in mind that zones 1-6 are the threshold area of the door, while zones 7-24 are the swing side of the door. To select a different width pattern, press the  button followed by the corresponding number. To select a different pattern depth, press  followed by the corresponding number.

#1 Wide Pattern

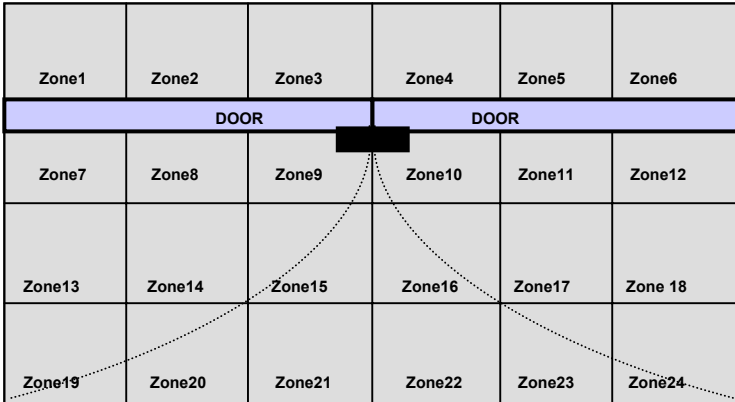

#2 Middle Pattern

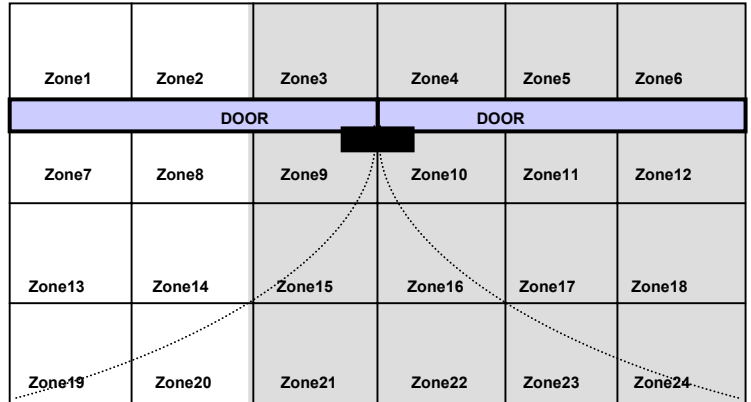

#3 Asymmetric Left Narrow

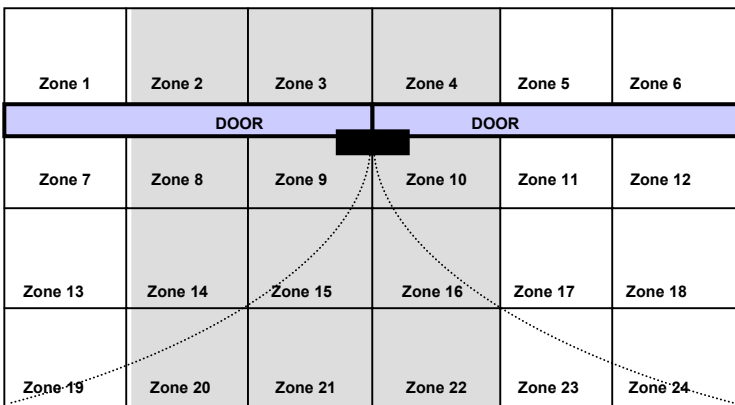

#4 Asymmetric Right Narrow

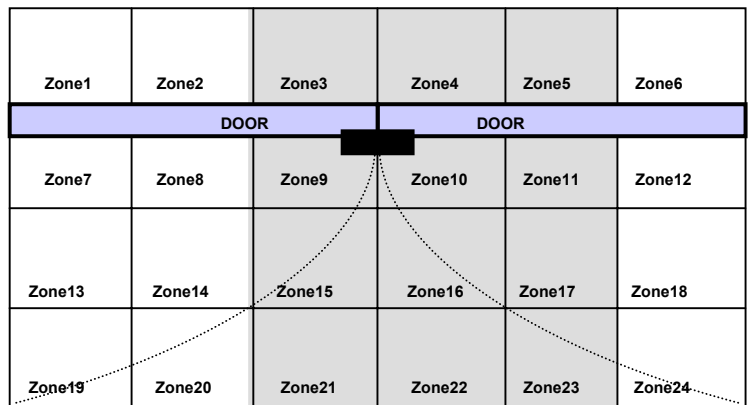

#5 Left Narrow

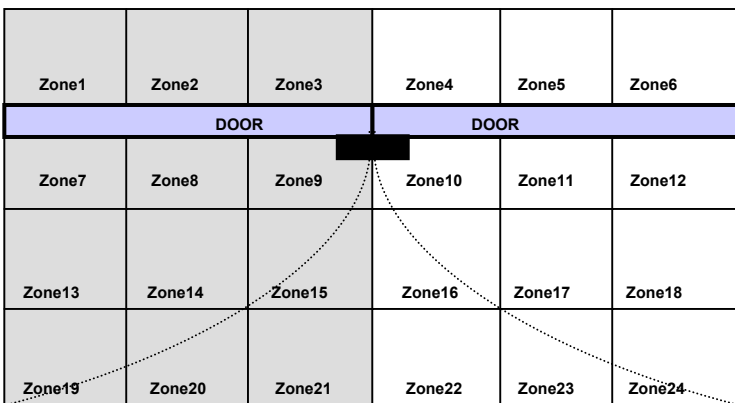

#6 Right Narrow

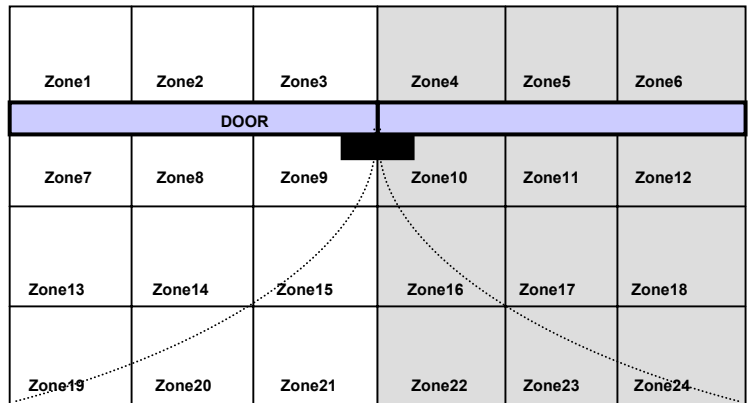

#7 Asymmetric Left Wide

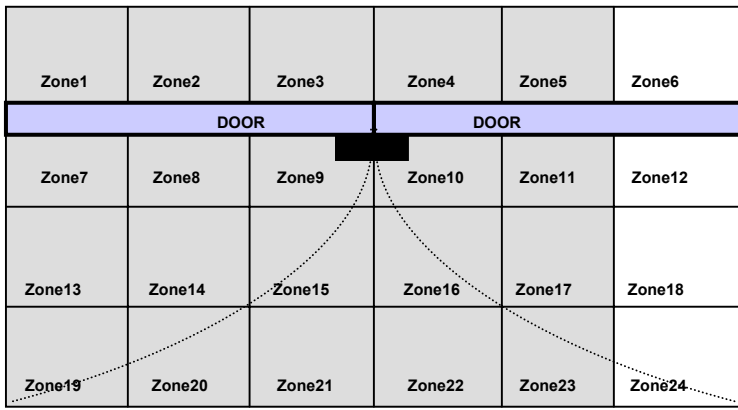

#8 Asymmetric Right Wide

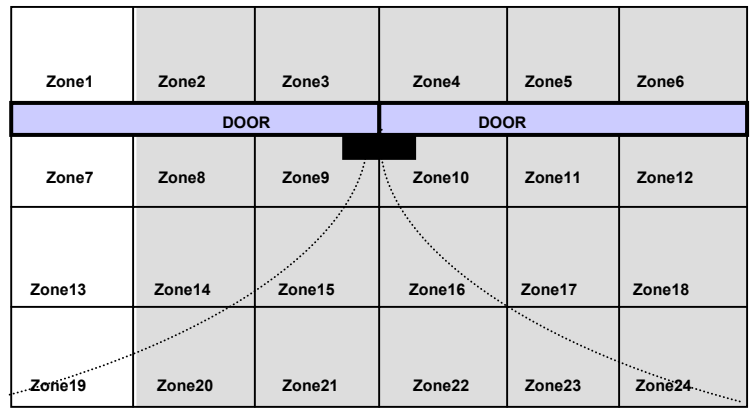

#9 Center Narrow

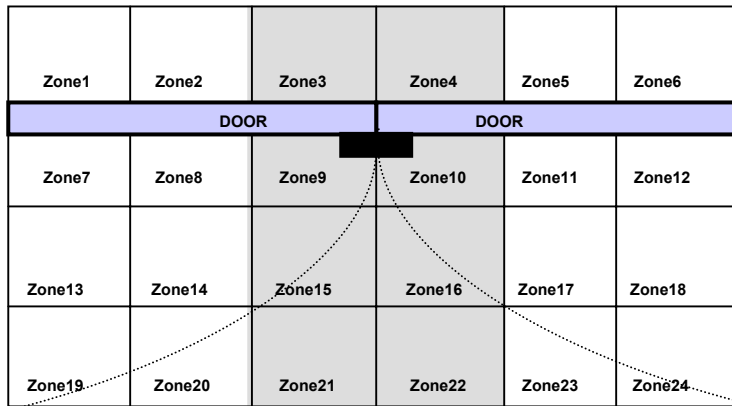

DEPTH PATTERNS

#1 Deep

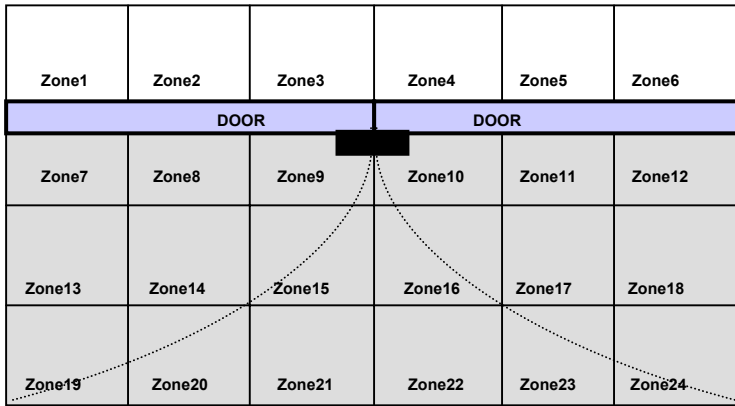

#2 Medium

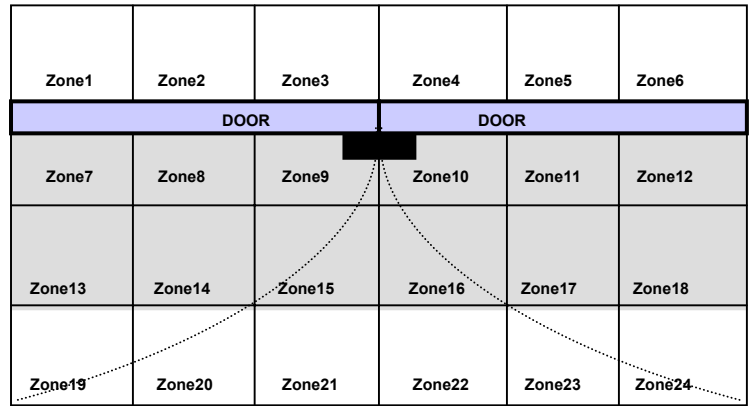

#3 Limited

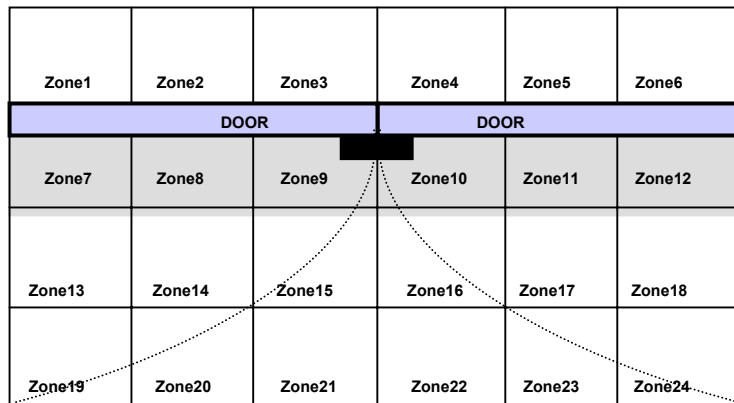

TROUBLESHOOTING

SENSOR WILL NOT SET-UP UPON INITIAL POWERING

1. Check terminal 1 & 2 for proper voltage - 24 Volts AC/DC \pm 10%.
2. Make certain that the field of detection is all clear during the set-up and that all lenses are installed on the sensor. If detection of movement is encountered upon initial set-up, the sensor will continuously flash Green at \pm 2 Hz. The sensor will also not set-up if permanent stationary objects are extremely close to the sensor. Ensure that, not only the detection field is clear, but also that the sensor is mounted properly. If the optional mounting block is not used, and the backside of the sensor is less than 3" to the face of the door, it may be in saturation due to the door. Install the optional mounting block if necessary.
3. Ensure that all wiring connections have been properly made. Refer to wiring diagrams on Page 4,5 and 6.

SENSOR WILL NOT SET-UP AFTER PROGRAMMING

1. Ensure that no movement is occurring within the field of detection. If the sensor detects movement beyond 20 seconds in its field while set-up is taking place, the Green LED will begin flashing at a slower rate of \pm 1 Hz to indicate an unsuccessful set-up. If this occurs, check to ensure that the backside of the sensor is more than 3" to the face of the door, it may be in saturation due to the door. If there is adequate distance, increase the angle of detection to 10° and try the set-up again. Make sure that all lenses are in place before initiating a set-up.
2. If the sensor successfully completes a set-up upon powering, but then will not set-up after programming, reset all parameters to the factory default by pressing  followed by number 3 or simultaneously pressing PB1 & PB2 at the right side of the sensor (see page 11).
3. Start the programming procedure over, if successful set-up cannot be obtained thereafter, replace faulty sensor.

DOOR WILL NOT OPEN ONCE SET-UP HAS BEEN COMPLETED

1. Check to ensure that there is no detection occurring at the sensor. If the Red LED is on steady, there is detection. Make sure there have been no changes in the field of detection since set-up. If permanent changes have occurred, launch a new set-up and re-test door.
2. Check the setting of the Relay Mode. Relay should be set to Active Mode for most applications. Refer to page 7 "To Inquire About A Setting." When the relay is in the Active Mode, the relay contacts will be closed when the Red LED is on, and open when the Red LED is off. If the relay output, when tested with an Ohm Meter, is closed regardless of the Red Led, and the Relay Mode is set to "Active Mode", replace faulty sensor.
3. Disconnect safety wire from door control. Activate door - if door still does not open, the fault lies within the automatic door control, not the sensor. If door does open, re-connect wires.

DOOR WILL NOT CLOSE OR SENSOR WILL NOT INHIBIT DURING CLOSING

1. If the Red LED is illuminated, launch a new set-up for the "door open" position. If Red LED goes out after Set-Up, walk-test the pattern and tune if necessary.
2. If Red LED comes back on when door goes open after new set-up, the sensor may not be going into the "door open" pattern.
3. Ensure that the wires are connected properly.

GREEN LED FLASHES STEADILY AT A RATE OF \pm 2Hz

If the sensor has tried to launch a new set-up after the expiration of the Automatic Learn Time due to a permanent change in the field of detection, and there is continual movement in the field, the sensor will flash the Green Led indefinitely until movement has stopped. This may also occur if there is an object that is extremely close to the sensor, thereby causing saturation. Once the object or movement has been eliminated, clear the field of detection. The sensor should set-up within 5 seconds and the Green LED should go out. Walking in and out of the detection field should cause the Red LED to come on and go out respectively thereafter.

RED LED FLASHES SLOWLY AT A RATE OF \pm 1 Hz

1. Unsuccessful set-up has occurred. Complete a new set-up according to Quick Reference Guide procedures on Page 2.
2. If problem persists, return all parameters to the factory defaults by pressing  followed by number 3 or simultaneously pressing PB1 & PB2 at the right side of the sensor (page 9).
3. Launch a new set-up. If Red LED continues to flash slowly, replace faulty sensor.

RED LED DOES NOT FLASH WHEN UNLOCKING FROM THE REMOTE CONTROL

1. Replace faulty batteries in remote control
2. If problem persists, the remote control or the sensor may be faulty. If possible, test the remote control on a working sensor. If remote control works, replace faulty sensor. If not, replace the remote control. At this point set-up may be accomplished according to page 10, "Non Remote Set-Up".

DO NOT leave any problem unresolved. If you must wait for the following workday to call Dor-O-Matic, leave the door inoperable until satisfactory repairs can be made. **NEVER** sacrifice the safe operation of the automatic door or gate for an incomplete solution.